

Operation Manual

Model V6-CF Series 700 Controller

BARTLETT

— INSTRUMENT COMPANY —

1404 Avenue M
Fort Madison, IA 52627

319-372-8366

www.bartinst.com

Table of Contents

INTRODUCTION	2
PRECAUTIONS	2
CONTROLLER FRONT PANEL	3
QUICK START	4
FIRST FIRING OF THE KILN	5
PROGRAM THE CONTROLLER.	5
REVIEW THE SAMPLE PROGRAM BEFORE FIRING.	6
START THE FIRING.	7
REVIEW THE RESULTS	7
CONE FIRE PROGRAMMING	8
VARY-FIRE	9
VARY-FIRE PROGRAMMING STEPS	9
CALCULATING RAMP RATES FOR VARY FIRE:	10
WRITE YOUR OWN CONE FIRE PROGRAM	11
START THE FIRING	11
OPERATION OF THE CONTROLLER DURING A FIRING	12
END OF FIRING - CPLT	14
REVIEW THE RESULTS	14
VIEW (INFORMATION) SECTION	15
CONE TABLE	15
REVIEW PROGRAM	15
VIEW SEGMENT	16
ONE-TOUCH INFORMATION (HOT) KEYS	16
OPTIONS SECTION	17
DELAY - THIS KEY IS USED TO DELAY THE START OF A FIRING	17
ALARM	17
MENU	18
ZONE CONTROL	22
1. FEATURES AND ENHANCEMENTS	22
2. GENERAL DESCRIPTION	22
3. AUTOMATIC LAG FUNCTION	22
4. THERMOCOUPLE OFFSETS	22
5. THREE THERMOCOUPLES	23
APPENDIX A - CONE FIRE TEMPERATURE PROFILES	24
APPENDIX B - ERROR CODES	25
FULL POWER TEST	26
APPENDIX C - COMMON QUESTIONS AND SITUATIONS	28
APPENDIX D - FIRING PROGRAM BLANK	29
APPENDIX E - CONNECTION DIAGRAM	30

Introduction

This manual covers the operation of the V6-CF series 700 kiln controller. The V6-CF is a versatile controller that regulates the temperature in your kiln so you can fire a variety of products like ceramics, glass, or jewelry. The experienced operator can go straight to the quick start guide. The novice can learn more about different types of firing by reading the programming sections of the manual and the ceramics and glass introductions on our web site www.bartinst.com.

In the following pages:

First Firing steps you through the initial firing for new kilns to “season” the elements.

Controller Front Panel is a visual table-of-contents for the function of each key on the face-plate.

Cone Fire is the quick, easy method of programming for ceramics.

Vary Fire (also known as ramp-hold) is the versatile programming method for writing your own profiles for glass, jewelry and ceramics.

The other sections of the manual will answer questions about what to expect during a firing.

Precautions

The controller is used to control temperature; it is not a safety device.

Do not operate the controller in temperatures above 125°F.

Always supervise your kiln during a firing.

The controller contains electronic components which are sensitive to static electricity. Before handling the controller dissipate any static charge you may have by touching metal or a screw on the controller panel, the electrical box, the kiln lid, or some other grounded object.

Always check the position of the thermocouple probe before starting a firing. The current temperature displayed on the controller is measured at the end of the thermocouple which must be in the firing chamber about 1” to 1-1/2”. Seal the opening around the thermocouple with kaowool or similar material if necessary.

Always review the current program (by pressing Review Program) before firing to ensure the correct profile is programmed.

Ensure the kiln and the areas around the kiln are clear of combustible material. See kiln manufacture’s recommendation on required clearances.

Controller Front Panel

START-STOP
p. 11

VARY-FIRE
ENTER PROG p. 9
RECALL PROG p. 11

OPTIONS
Delay p. 17
Alarm p. 17
Menu p. 18
In Menu
RSET p. 18
PRHT p. 18 & 19
Id p. 18
16-S p. 18 & 19
CNOS p. 18 & 20
CHG° p. 18
ERCd p. 18 & 21
TCOS p. 18, 20, 21
bd T p. 18

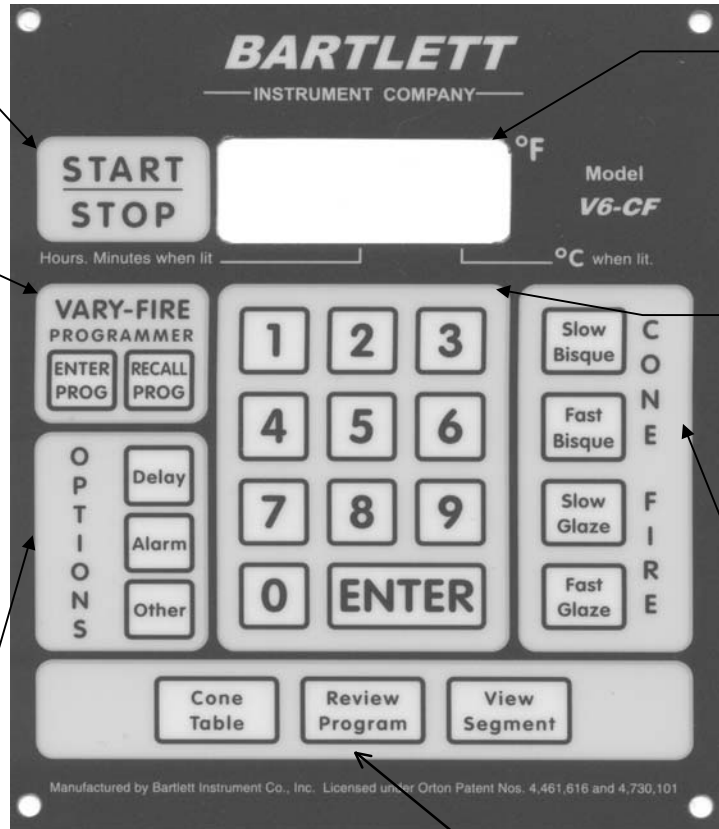

LED DISPLAY
Decimal in lower right indicates temperature in °C. Decimal in middle indicates a time.

NUMBER KEYS
for entering temperatures and times.
Hot Keys p. 16

CONE FIRE
p. 8
Create your own custom cone fire program p. 11

VIEW p. 15
Cone Table p. 15
Review Program p. 15
View Segment p. 16
Hot Keys p. 16

QUICK START

1. Read all precautions before using your controller.
 2. Apply power to the kiln/controller
 3. Clear the display and get to the idle mode by pressing ENTER.
 4. Program the controller.
 5. Review the program before firing to ensure the correct program is ready to fire.
 6. Press Start. -On- will be displayed and then the kiln temperature. The relays and elements will be cycled on and off to regulate the temperature according to the program.
 7. At the end of the firing the controller will flash the current temperature, firing time, and CPLt. Press ENTER to return to the IdLE state.
- **IMPORTANT PROGRAMMING NOTE:** Before initiating a firing profile or performing any other function, the controller must be at IdLE. Pressing the ENTER key will clear the display of errors (E-) or FAIL.
 - In most cases when programming, you will choose an option, then press ENTER to accept the option.
 - With the display flashing IdLE alternating with the current temperature, you are ready to proceed with programming.
 - The CONE FIRE mode uses a patented method to achieve correct heat-work so it is ideal for firing ceramics. The advantage of using the CONE FIRE method is that a very complicated firing profile may be chosen with just a few key strokes. The CONE FIRE method helps protect against over and under firing by carefully tracking and controlling the temperature at the end of the firing as the cone temperature is approached. The final temperature is adjusted according to the final firing rate. For example, as the heating elements age and the heating rate slows, the final temperature will be adjusted downward to ensure the correct amount of heat-work.
 - The VARY-FIRE mode can be used for ceramics, glass, jewelry, glazes, decals, etc. It allows you to create your own firing profiles which can be saved and used over and over.
 - If there is a kiln sitter on the kiln it must be set according to the manufacturer's directions. Insert a cone in the sitter that is one or two cones hotter than the controller setting.

First Firing of the Kiln

The purpose of the first firing is to put a protective oxide layer on the elements and thermocouple. The first firing is done without ware in the kiln that might give off fumes that contaminate the elements. This first firing should have shelves and witness cones. The witness cones should be on the middle of the shelf nearest the center of the kiln. The programmed cone number should match the cones provided with the kiln. Our example calls for a cone 04 firing but if your kiln is supplied with different cones, substitute that cone number in the programming.

The first firing should be done according to the kiln manufacture's specifications if they are different from these instructions.

1. Apply power to the kiln/controller. The display will show WAIT, and then go to IdLE.
2. If the display shows PF press ENTER to proceed to the IdLE state.

Program the controller.

This example is for a Fast Glaze to cone 04 with no hold time at the end of firing.

Press	Fast Glaze	Display will show F-GL
Press	ENTER	Display will show CONE/xxx
Press	0	0
Press	4	04
Press	ENTER	Display will show HOLd/ 0.00
Press	ENTER	Display returns to IdLE/temp

Review the sample program before firing.

Press Review Program key, the display will cycle through the following information.

Display shows	Description
F-GL	Firing speed, fast glaze
PRHT/0.00	Shows zero preheat time
CONE/ 04	Programmed for cone 04
°F /1945	Top temperature for cone 04
CNOS/0	Shows 0°F cone adjustment
HOLD/0.00	Indicates zero hold at the top temperature
dELA/00.00	Indicates delay start of 0
ALRM/9999	Alarm is disabled
ERCD/ on	Error detection is enabled
FIRE/xxxx	Shows the number of firings done with this controller

Start the Firing.

Press start to begin the firing	The display will show -ON- then the current temperature. You will hear clicking when the relays cycle power to the elements to regulate the temperature. This firing will take around 6 to 7 hours.
End of firing CPLT	At the end of the firing, the display will flash between CPLT / Firing time / kiln temperature
Press ENTER to return to IdLE	The display will now flash IdLE / kiln temperature. You may open the kiln when the temperature has cooled to 150°F.

Review the Results

A properly bent cone indicates that the kiln is functioning properly and accurately. The tip of the cone will be level with the top of the cone's base when fired properly. The diagrams below will give you an idea of a properly fired, under fired and over fired cone. Some variation from a proper bend is expected and can be compensated for with the cone offset adjustment for each particular cone number based on test firings.

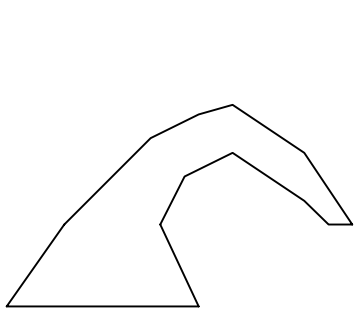

Proper bend

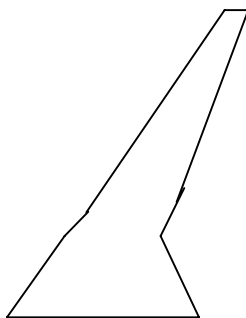

Under fired

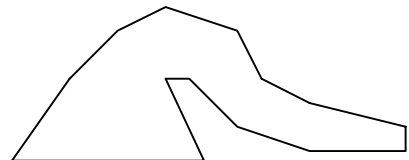

Over fired

CONE FIRE Programming

This is the quickest and easiest method to program the controller to fire ceramics. Programming consists of choosing the firing speed and entering the clay or glaze's cone number. The firing speed is chosen by the type of firing and thickness of the clay. The bisque firings include water smoking and carbon burn-out stages. The glaze speeds allow for faster firings. All 4 speeds will calculate the firing rate at the end of a firing and adjust the final temperature for correct heat-work. Follow these few steps to enter a cone fire program.

Press	Slow Bisque	Display shows S-bC	The slow bisque speed is used for thicker hand thrown ware. The slow speed gives extra time for release of water and carbon burn-out. Typical firing times range from 13-17 hours depending on the cone #. Hand built pieces may need a preheat stage.
	OR Fast Bisque	Display shows F-bC	The fast bisque speed is for thinner ware that requires less time for water smoking and carbon burn-out. Firing time is 9 – 11 hours, typically, and depends on the cone number.
	OR Slow Glaze	Display shows S-GL	Slow glaze is used for firing glaze on thicker ware or for bisquing very thin ware. Typical firing time is 6-8 hours depending on the cone number.
	OR Fast Glaze	Display shows F-GL	Fast glaze is the fastest speed and is used for glaze firing on thin ware, china paint firings, and decal firings. Firing times range from 4 to 5 hours
Press	ENTER	Display shows CONE/xxx	The displayed firing speed was accepted and now the controller is waiting for the cone number to be entered. The x's represent the cone number last selected.
Press	Number keys for cone number	Display shows xxx	Use the number keys to display a new cone number. Remember, cone numbers starting with a 0 are lower temperature than cone numbers not starting with a 0. For example, don't mistake a cone 6 for a cone 06!
Press	ENTER	Display shows HOLd/0.00	The displayed cone number was accepted and now the controller is waiting for the hold time at the top temperature to be entered. Usually this value is left at 0. If a time is entered the hours are to the left of the decimal and the minutes to the right.
Press	ENTER	Programming complete Display is back to Idle	Zero hold was accepted and programming is complete.

NOTE - A preheat segment for drying (candling) ware can be added to any cone fire program. See **options** section for PREHEAT instructions.

TEMPERATURE REACHED at the end of a cone fire program:

When the display is at IdLE, pressing Review Program, will show the heat-work adjusted temperature that was reached. The temperature is displayed after °F in review program. This temperature will remain until the controller is reprogrammed. Record this temperature in your log after each cone firing.

VARY-FIRE

The V6-CF has 6 vary-fire user programs to store and reuse. Each program has from 1 to 8 segments (2 to 16 segments if 16-S option is on). Each segment has a firing rate, a soak temperature, and a hold time.

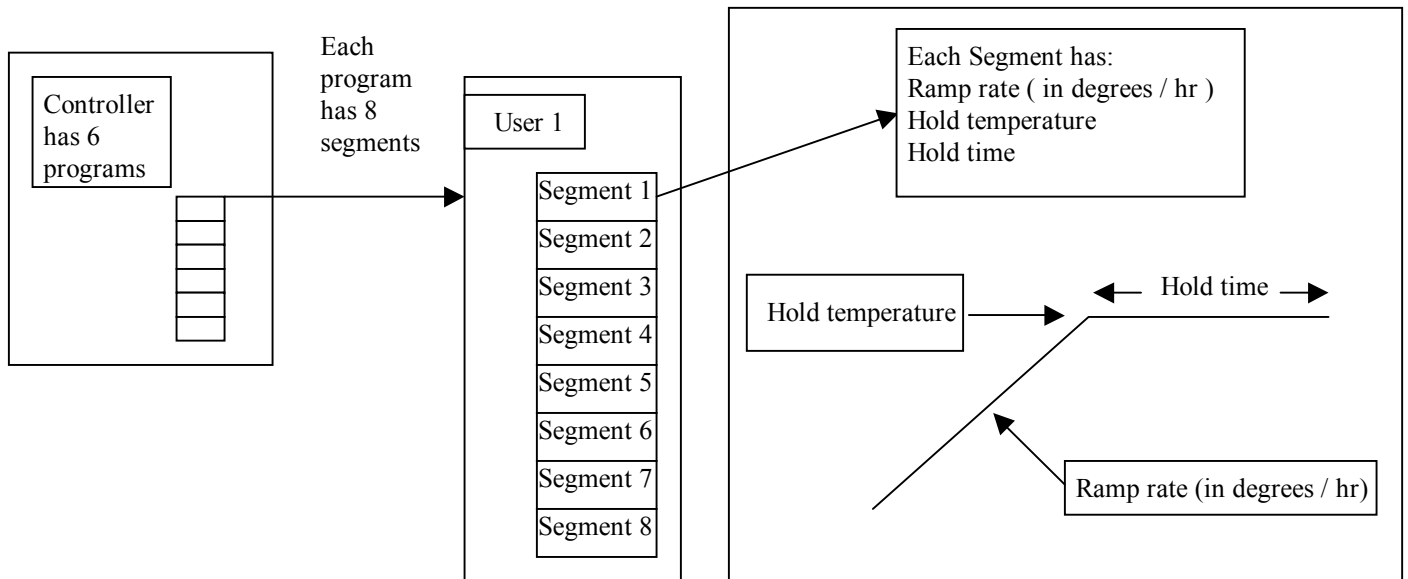

Vary-Fire programming steps

1. Press "Enter Prog" to start Vary-Fire programming – the display will show USER/#
2. Select User number – Press a number key 1-6 then ENTER.
3. Enter number of segments – Press a number key 1-8 then ENTER
4. Enter the ramp rate for segment 1 – Type ramp rate then press ENTER. Rates of 1 thru 9999°F/hr are valid. See note for calculating ramp rate.
5. Enter the hold temperature for segment 1 – Type hold temperature then press ENTER. Valid temperatures range from 1°F thru MAX kiln temperature.
6. Enter the hold time for segment 1 - Type hold time then press ENTER. Displayed time is in the format **hr.min.** Left of decimal are hours, to the right of decimal are minutes.
7. Repeat steps 4 – 6 for each segment.
8. Enter an alarm temperature – Type an alarm temperature then press ENTER. See **OPTIONS** section for more information on alarm temperature. The alarm set at 9999 is turned off.

The following are notes to help with programming a Vary-Fire program. APPENDIX A CONE FIRE PROFILES can be used as a starting point for a Vary-Fire program for ceramics.

NOTES: For Vary-Fire programming

1. The first ramp rate of any user program must be an increasing ramp which means the segment temperature must be greater than the starting kiln temperature.
2. To ramp up or down at the maximum rate, enter a rate of 9999.
3. To program a down ramp, you enter the rate/hour then a temperature below the previous segment's temperature.
4. It is best to write out the firing profile that you plan to program before you begin programming. At the end of the Operation Manual there is a blank form for writing your firing programs. Photo-copy as needed.

Calculating ramp rates for VARY Fire:

If you want to go from room temperature to 750°F in 3 hours, here is how to calculate the ramp rate. Take the temperature that you want to go to (750°F) minus the starting temperature (70°F - approximate room temperature) to get the number of degrees you want to increase in 3 hours ($750 - 70 = 680$). Divide this number by the time you want to get to 750 to give you the ramp rate ($680^{\circ}\text{F} \div 3 \text{ hrs} = 227^{\circ}\text{F/hr}$).

If you want to add another segment to go from 750°F to 1000°F in 4 hours, the same procedure is used. Take the end temperature minus the starting temperature ($1000 - 750 = 250$) and divide this number by the number of hours to reach 1000°F ($250^{\circ}\text{F} \div 4 \text{ hrs} = 63^{\circ}\text{F/hr}$).

RECALL PROGRAM is used to recall a previously programmed firing profile.

Example: To recall user program #5, use the following:

Step	Press	Display	Comment
1	RECALL PROG	Alternately flashing: USER & 1	The controller is ready to accept the desired user number.
2	5	5	Indicates the user program selected.
3	ENTER	Programming complete Display is back to Idle	User program #5 has been selected. . The current temperature then flashes in the display.

WRITE YOUR OWN CONE FIRE PROGRAM

Writing your own cone fire program combines the versatility of the Vary-Fire program and the heat-work calculation of a cone fire program. It is a great way to get custom heating and cooling rates and still have the controller do the heat-work calculation to get the correct cone bend regardless of firing rate. The steps to write your own cone fire are the same as entering a Vary-Fire program except when you are programming the top temperature press the CONE TABLE key and enter the desired cone number then press ENTER. The cone number and cone temperature will be displayed in the program review. The cone temperature can be entered into any segment so you can also have cool down segments in the program.

Start the Firing

Press Start to begin the firing	The display will show -ON- then the current temperature. You will here clicking when the relays cycle power to the elements to regulate the temperature.
---------------------------------	--

Operation of the Controller during a firing

The V6-CF controller eliminates much of the “babysitting” that is required with a manual kiln. To ensure the most consistent results from one firing to the next, you should understand how the controller operates and monitor the firing to ensure proper operation. The block diagram and flow chart show the basic components of a kiln’s control system.

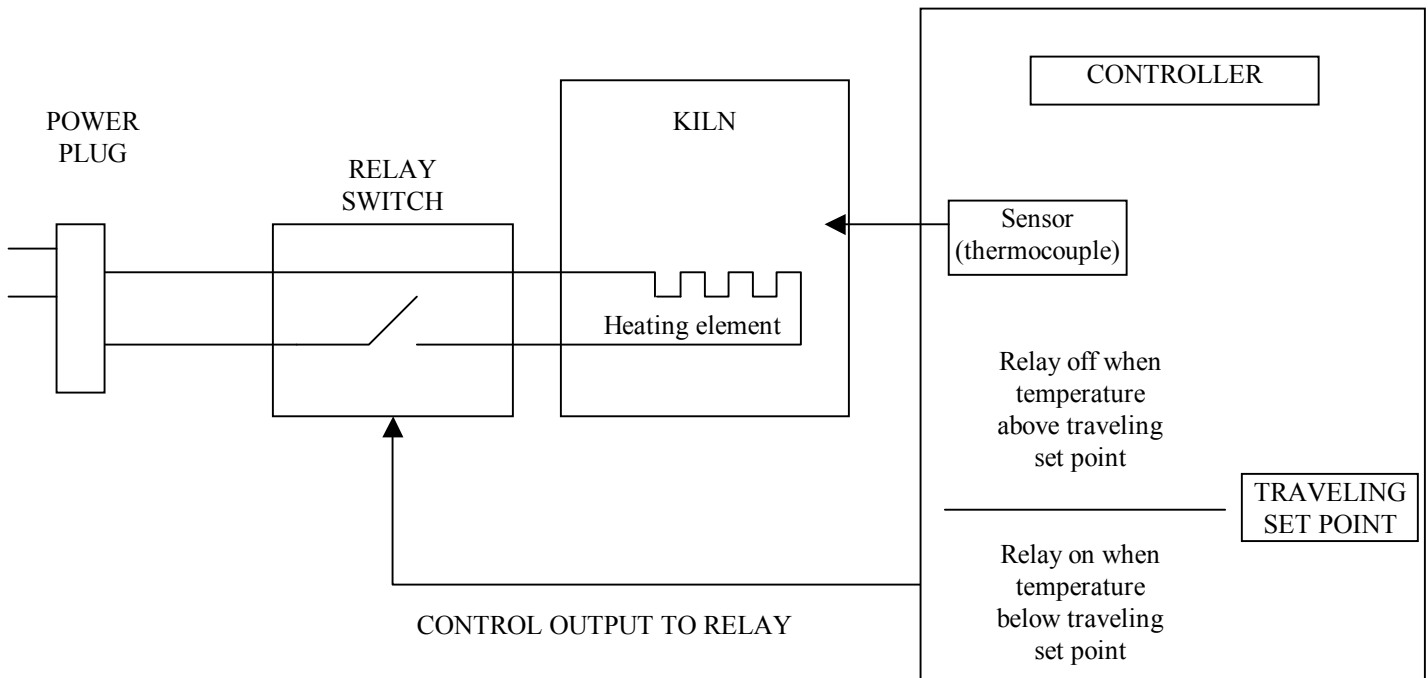

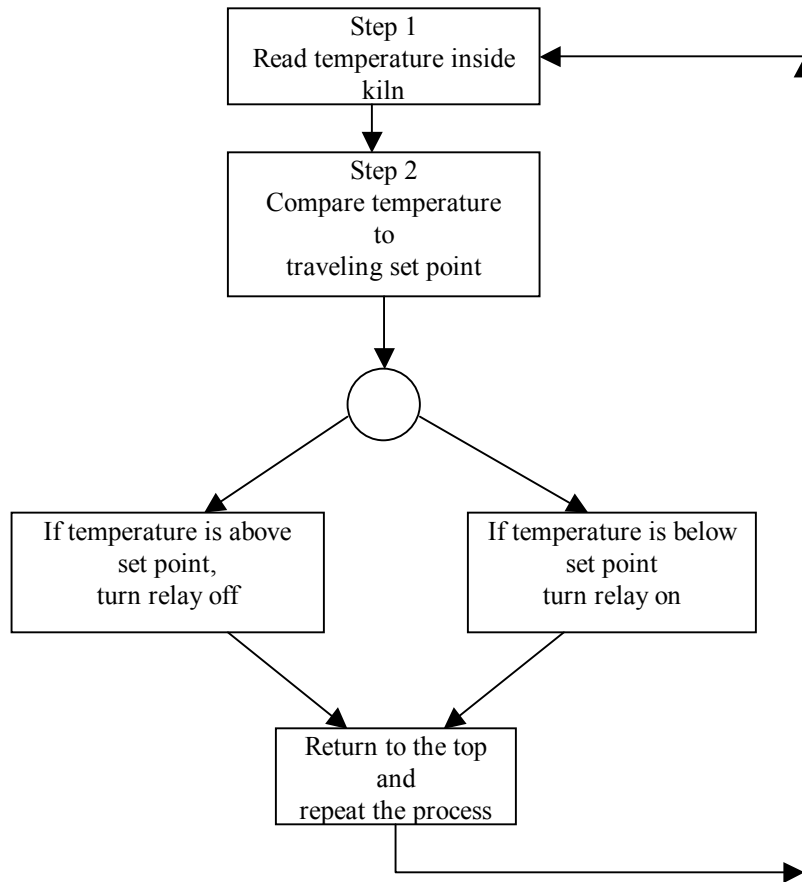

Controller Flow Chart

The block diagram and flow chart show that the kiln control system, in its simplest form, works like your thermostat at home – when the temperature is too cool the heater comes on; when the temperature is too hot the heater turns off. The major components of the control system are the V6-CF controller, thermocouple temperature sensor, relay switch, power source and heating elements. The controller is the brain of the operation; the controller adjusts the traveling set point according to your program, reads the temperature in the kiln, cycles the relay on or off and determines when to end the program.

The thermocouple (t/c) sensor is the first part to inspect when loading the kiln. The tip of the t/c should protrude 1" to 2" into the firing chamber. Next, "START" is pressed, the controller reads the kiln temperature and uses that temperature as a starting point for a traveling set-point (also called the local set-point). The displayed temperature is the temperature inside the kiln. You should then hear the relay(s) start cycling on and off to keep the temperature near the traveling set point. As the firing progresses the controller moves the traveling set-point according to the programmed firing rate. The displayed temperature should increase with the traveling set-point and the relay will be "on" longer. This sequence continues until the final temperature is reached and the controller turns off the kiln. The display reads "CPLT".

END OF FIRING - CPLT

End of firing	At the end of the firing, the display will flash between CPLT / Firing time / kiln temperature
Press ENTER to return to IdLE	The display will now flash IdLE / kiln temperature. You may open the kiln when the temperature has cooled to 150°F.

Review the Results

After a firing record the firing time, and load size. In your log keep any repair information. If cones are placed in the kiln, record the amount of bending that took place.

A properly bent cone indicates that the kiln is functioning properly and accurately. The tip of the cone will be level with the top of the cone's base when fired properly. The diagrams below will give you an idea of a properly fired, under fired and over fired cone. Some variation from a proper bend is expected and can be compensated for with the cone offset adjustment for each particular cone number based on test firings.

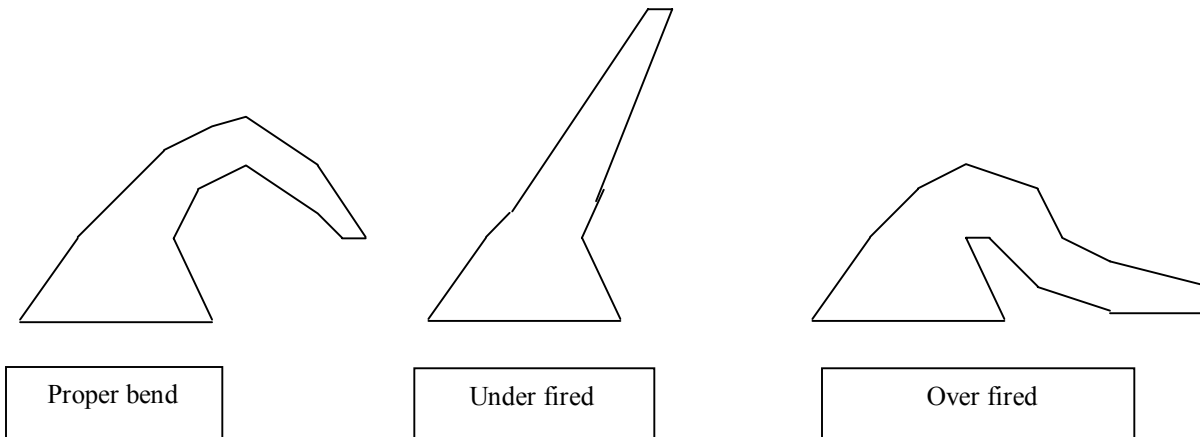

NOTE – An error code (E-) in the display indicates an abnormal end to a firing. See the Error code section to help determine the reason for the error code.

VIEW (information) SECTION

View Section - Contains buttons to look up cone temperatures, review programs, and view the current segment. View Segment is also used to skip step during Vary-Fire Programs.

Cone Table - Used to look up the temperature of various cone numbers. The temperature that is displayed is for self-supporting cones with a heating rate of 108oF/hr. To use, press Cone Table, enter the cone number you want to look up, press ENTER; the cone temperature will be displayed then the controller returns to IdLE.

Review Program - The information displayed when Review Program is pressed varies depending on whether you are using Cone Fire or Vary Fire. When Review Program is pressed, each of the steps in the current firing profile is displayed one after another changing every ½ second.

In **Cone Fire Mode** - The display will show the selected firing profile in the following order:

Display shows	Description
F-GL	Firing speed, fast glaze
PRHT/0.00	Shows zero preheat time at 200°F
CONE/ 04	Programmed for cone 04
°F /1945	Top temperature for cone 04
CNOS/0	Shows 0°F cone adjustment
HOLD/0.00	Indicates zero hold at the top temperature
dELA/00.00	Indicates delay start of 0
ALRM/9999	Alarm is disabled
ERCD/ on	Error detection is enabled
FIRE/xxxx	Shows the number of firings with this controller

In **Vary Fire Mode** - The display will show in the following order:

- the user program # (USER)
- the number of segments (SEG)
- 1st ramp rate (rA 1)
- 1st segment temperature (°F 1)
- 1st hold time (HLd1)
- (If there is more than 1 segment, then the ramp rate, segment temperature, and hold time of each of the other segments will be displayed in order.)
- delay time (dELA)
- alarm setting (ALAr)
- error codes on/off (ErCd)

View Segment - only functions when a firing is in progress. View segment is used to view the current firing segment or to skip from the current segment to the next firing ramp. **When View Segment is pressed during a firing the following 4 items are displayed in this order, the current segment of the firing, the calculated rate, the travelling set-point (SETP, the traveling set-point should be near the current kiln temperature), and the circuit board temperature.** If View Segment is pressed during IdLE, StOP is displayed then the current temperature.

Skip Step (SKIP) - Skip Step is included in View Segment. The skip step feature is only available with VARY-FIRE programs. It is used when enough heat work has been done at the current segment and you want to immediately go the next ramp rate. To skip to the next ramp, press View Segment, then within ½ second, press ENTER, and ENTER a second time. If you press View Segment and do not press ENTER within ½ second, the current segment (e. g., rA 1) will continue to be displayed. Simply wait until the temperature is again displayed and press View Segment, then ENTER within ½ second, and ENTER again. If you press View Segment, then ENTER, then decide not to skip to the next ramp stage, simply do not press any key; after about 10 seconds the display will return to the current temperature.

One-touch information (hot) keys

Key to touch	Description of information displayed
5	Displays the rate of temperature rise over the last 22.5 minutes of the firing. Diagnostic tool used to check if the firing is keeping up with the programmed rate.
7	If your kiln is supplied with a current sensor, pressing 7 displays the amperage reading of each section of the kiln during a firing. If no current sensor is connected the AMPS will read near zero.
8	Output indicator lights. This diagnostic routine uses the decimal points to indicate which section the controller is trying to heat. The left most decimal point is the top section, 2 nd decimal from left is the middle section, and 3 rd decimal from left is the bottom section. If the kiln has only one t/c then all 3 decimals come on simultaneously.

0	Shows the elapsed time of a firing. Helps track the progress of a firing. Hours are to the left of the decimal and minutes to the right.
---	--

OPTIONS SECTION

Delay - This key is used to delay the start of a firing.

Example: Program a one hour delay to the start of a firing.
Remember: The controller must be at IdLE to begin programming.

Step	Press	Display	Comment
1	Delay	Alternately flashing: dELA and 00.00	The controller is ready to accept the delay time of 1 hour.
2	1, 0, 0	01.00	Displays the selected time. Numbers to left of decimal point are hours, to the right of decimal point are minutes. If you type a wrong number, press zero 4 times, then type the correct number.
3	ENTER	Current Temperature	The 1 hour delay has been accepted. The current temperature then flashes in the display. When START is pressed the delay time will display and count down to zero.

Caution – Make sure kiln area will stay clear and safe throughout the delay time and firing time

Alarm - This key is used to set the high or low temperature alarm. The alarm may be set before or during a firing. When the alarm temperature is reached, a buzzer will sound. It has no other effect on the firing.

Example: Before the start of a firing, set the alarm temperature to go off at 200°F.
Remember: The controller must be at IdLE to begin programming.

Step	Press	Display	Comment
1	Alarm	Alternately flashing: ALRM and #	The word ALRM and the last entered alarm temperature will alternately flash on the display. The controller is ready to accept the alarm temperature. If no alarm is entered within 10 seconds, the display will return to the current temperature.
2	2, 0, 0	0200	Displays the selected temperature of 200. If you type a wrong number, press zero 4 times, then type the correct number.
3	ENTER	Current Temperature	The alarm temperature has been accepted. The current temperature then flashes in the display.

Menu – The menu is a list of options that allow you to add segments to a firing (PRHT, 16-S), adjust calibration (CNOS, TCOS), change settings (CHG°, Id, RSET, ERCd), or check board temperature (bd T). Navigate forward through the menu by pressing MENU and navigate backwards through the menu by pressing ALARM.

NOTE: PrHt (Preheat) will only appear in this menu when a CONE FIRE program has been selected. 16-S will only appear when a Cone fire or User 5 is the selected program.

TO EXIT this menu without selecting any option, press STOP

MENU ITEM	DESCRIPTION
RSET	Resets the t/c offset to 0 and sets error codes to on. Press MENU until “RSET” is displayed and then press ENTER to activate the reset.
PRHT	PRHT shows in the menu only when a cone fire is programmed. Preheat is used with the CONE FIRE mode only. When Preheat is selected, the temperature ramps up at 60°F/hour (33°C/hr) to 200°F (93°C) and then holds at 200°F (93°C) for the amount of time programmed. Preheat is automatically set to zero during cone fire programming and at the end of each firing. Therefore, if a preheat stage is desired, it must be reprogrammed for each firing and be the last item programmed before START is pressed. SEE PREHEAT EXAMPLE ON NEXT PAGE.
Id	Identification number for KISS computer interface
16-S	Is only in the menu when a Cone Fire or User 5 is programmed Connects User 5 or a Cone fire program to User 6. 16-S/on flashes during program review when this option is enabled. See notes on next page.
CNOS	Adjusts the heat-work for each cone number individually. This affects only the cone number adjusted. SEE PAGE 20.
CHG°	Switches between °F and °C
ERCd	Allows the error checking of the controller to be turned on or off.
TCOS	Adjusts the calibration of the temperature readings. This adjustment affects all cone numbers and user programs. TCOS is usually used to balance a multi-zone controlled kiln.
bd T	Displaying the board temperature is a diagnostics function to check the operation of the board. Used to ensure a FAIL message is due to a bad TC and not due to a faulty controller. Press Menu until “bd T” is displayed then press ENTER. The temperature measured at the circuit board will be displayed for about 1 second. If you get a “FAIL” message and board temperature is approximately room temperature then the thermocouple is faulty.

Preheat Example: Set a preheat time of 2 hours. Remember: The controller must be at IdLE to begin programming

Step	Press	Display	Comment
1	Menu	PrHt	If PrHt does not show on the display, even after cycling through the options, it means that CONE FIRE mode has not been selected. Exit the menu and select a CONE FIRE speed, then return to the Menu.
2	ENTER	Alternately flashing: HLd & 00.00	Preheat has been selected; enter the time you want to hold the temperature at 200°F (in this example, 2 hours)
3	2, 0, 0	02.00	Displays the selected time of 2 hours. Numbers to left of decimal point are hours, to the right are minutes. If you type a wrong number, press zero 4 times, then type the correct number.
4	ENTER	Display returns to current temperature and IdLE	Accepts the 2 hour preheat time. The current temperature then flashes in the display.

16-S (16 segment program) Activate the 16-segment option by pressing the Menu key to display “16-S”. Press ENTER to accept the option. Press “1” until the display shows "On". Press ENTER to complete activation.

In the vary-fire mode, programs 5 and 6 can be combined into a 16-segment program. To combine User 5 and 6, first program user 5 then program user 6 (each program can have from 1 to 8 segments). Next, recall user 5 then activate the 16-segment option in the menu. Press Start and the controller will fire user 5 then it will fire user 6.

NOTE: In the vary fire mode, the first segment of user 6 must be an up ramp or the segment will be skipped.

In the cone-fire mode, a cone-fire program is connected to the vary-fire User 6 program. To combine a cone fire program with User 6, first, program User 6 then program a cone fire. Next, activate the 16-segment option in the Menu. This is a great way to add multiple cooling segments to a cone fire profile.

Important Note: In the cone-fire mode, the controller uses the first segment of user 6 to transition from the cone fire program to User 6 so the first segment of User 6 is ignored by the controller. This means that when you program the number of segments, you must enter 1 greater than the actual number of segments you need. You then start the actual programming with segment number 2. The controller will ignore any information you enter into segment 1 so as you program user 6 and the display shows RA 1, press ENTER, ENTER, ENTER to get to RA 2.

NOTE: 16-S will appear in REVIEW PROGRAM if it is activated.

Adjusting Cone Offset and Thermocouple (T/C) Offset.

	CONE Offset CNOS	T/C Offset TCOS
To Correct Under-firing	Set positive (00) cone offset	Set negative (90) t/c offset
To Correct Over-firing	Set negative (90) cone offset	Set positive (00) t/c offset

CNOS (Cone Offset) - Used to raise or lower the final cone temperature. The final cone temperature can be raised or lowered a maximum of 50°F (28°C).

When entering the offset temperature the following convention is used: the left two digits designate whether to raise (00) or lower (90) the cone temperature, that is, “00” means plus (+) and “90” means minus (-). The right two digits are the number of degrees the cone temperature will be raised or lowered.

Examples:

Number	Meaning
0020	Raise the final cone temperature by 20°F increases heat work
0040	Raise the final cone temperature by 40°F increases heat work
0015	Raise the final cone temperature by 15°F increases heat work
9030	Lower the final cone temperature by 30°F decreases heat work
9005	Lower the final cone temperature by 5°F decreases heat work
9045	Lower the final cone temperature by 45°F decreases heat work

The following apply to cone offsets:

- The final temperature is affected only for the cone number that you change and no other cone numbers.
- The cone offset will remain for that specific cone number until it is changed again.
- Typing just the offset amount will raise the final temperature and INCREASE the amount of heat work.
- Typing “90” before the desired offset amount will lower the final temperature and DECREASE the amount of heat work.
- The maximum number of degrees that can be raised or lowered is 50°F (28°C)
- Cone offsets do not affect the VARY-FIRE mode.

Cone Offset Example: Adjust cone 6 to shut off the kiln at 30°F below the prescribed cone temperature.

Step	Press	Display	Comment
1	Menu, Menu	CNOS	If CNOS does not show on the display, press the Menu key until CNOS displays.
2	ENTER	Alternately flashing: ConE & #	Cone Offset has been selected; the word CONE and the last entered cone number will alternately flash on the display. Now enter the cone number which you want to adjust (in this example cone 6)
3	6	6	“6” will be displayed. If you type a wrong number, press zero 3 times, press ENTER, then type the correct number.
4	ENTER	Alternately flashing: °FOS & number	°FOS and the previous offset alternately flash. Enter the new offset amount using the rules above, in this example, “9030”.
5	9, 0, 3, 0	9030	The selected offset temperature is displayed. If you type a wrong number, press zero 4 times, then type the correct number.

6	ENTER	The display returns to IdLE	The temperature adjustment has been accepted. The current temperature then flashes in the display. A cone 6 program will now fire 30° cooler.
---	-------	-----------------------------	---

TCOS (Thermocouple Offset) - Used to raise or lower the temperature indicated by the thermocouples. This is generally used to balance the heat-work in a zone controlled kiln. The maximum offset is 50°F (28°C). A positive offset displays only the amount and a negative offset is preceded by “90”. A negative offset will lower the indicated temperature reading and cause more heat-work. **When TCOS is displayed, press ENTER and the current offset for the thermocouple will be displayed. Press ENTER when the correct offset is displayed.**

The following apply to thermocouple (T/C) offsets:

- The final temperature is affected for all CONE FIRE and all VARY-FIRE programs.
- The thermocouple offset will remain for that T/C until it is changed again.
- Typing only the offset amount will raise the indicated temperature but it will lower the actual temperature in the kiln and LOWER the amount of heat work.
- Typing “90” before the desired offset temperature will lower the indicated temperature but it will increase the actual temperature in the kiln and INCREASE the amount of heat work.
- The maximum number of degrees that can be raised or lowered is 50°F (28°C).

ERCd - Used to turn on or turn off the error codes. When you receive your controller the error codes are turned on. In most cases, you want the error codes on to protect your firings. They can be turned off if you are doing special firings, such as jewelry or glass firing where the kiln is left open. They may also be turned off when troubleshooting kiln problems.

Example: Turn the error codes off.

Step	Press	Display	Comment
1	Menu, Menu	ERCd	If “ERCd” does not show on the display, press the “Menu” key until “ERCd” displays.
2	ENTER	ON	Indicates that the error codes are turned on. You can toggle back and forth between on and off by pressing the “1” key.
3	1	OFF	Displays “OFF” indicating the error codes will be turned off.
4	ENTER	IdLE	Error codes are off. The controller returns to IdLE and the current temperature.

ZONE CONTROL

Your kiln must have multiple thermocouples and be wired for multiple zones to take advantage of these features

1. FEATURES AND ENHANCEMENTS

- 3 separately controlled zones (3 t/c inputs, 3 outputs)
- Adjustable offsets for each thermocouple (t/c)
- Continues to fire with 1 or 2 failed thermocouples (t/c's)
- Slow ramping when any zone lags the set-point
- Reset function which zeros the t/c offsets, turns the errors on, and sets the lag to 13 degrees

2. GENERAL DESCRIPTION

The V6-CF advanced 3-zone control system is programmed the same as the single zone control but it has new features to ensure even firing from the top to the bottom of the kiln. A 3-zone control has 3 temperature sensor inputs (thermocouples) and 3 independent outputs so the kiln can have 3 separately controlled sections (zones). The controller senses the temperature in each section of the kiln, compares the temperature to the desired temperature (traveling set-point) and adjusts the power going to each section separately giving each just the right amount of power to keep the temperature at the correct setting. The single zone controller only measures the temperature at the center of the kiln and gives all sections the same amount of power.

3. AUTOMATIC LAG FUNCTION

Lag refers to when the temperature of a kiln's section "lags" behind the traveling set point because the programmed ramp rate is faster than the kiln's temperature can rise. The V6-CF series 700 will slow the ramp rate when a section of the kiln lags. The ramp rate determines the amount of "lagging" that is allowed before the firing rate is slowed. Fast ramp rates (>500 °F/hr) will allow the greatest temperature difference between sections. Slow ramp rates (<70 °F/hr) will have the smallest temperature difference between sections. Therefore, when the controller is programmed to go fast it will sacrifice evenness to obtain speed. Likewise, when the controller is programmed to go slow, the controller will maintain tighter control. The controller will try to balance speed and tight control when a medium speed is programmed.

4. THERMOCOUPLE OFFSETS

(see T/C offsets and Cone offsets in the OPTIONS SECTION for more information)

Normal variation in thermocouples (t/c) can cause a section to fire too hot or too cool. The zone control has an offset feature to adjust the reading of each thermocouple to compensate for any error. For example, if shelf cones indicate that the bottom section is under firing, it means that

the controller thinks the bottom section actually reached the ending temperature when it really was below the ending temperature. To correct this problem, a negative thermocouple offset is required. This offset will be subtracted from the actual reading and will lower the temperature reading in that section. A negative offset will cause a section to fire to a higher temperature increasing the heat-work for that section. A positive offset will cause a section to fire to a lower temperature decreasing the heat-work for that section. To return all t/c offsets to zero, press Menu, "RSET" will be displayed, press ENTER; RSET also turns the error codes (ERCd) on.

5. *THREE THERMOCOUPLES*

Besides better measuring of the temperature, the zone control also offers security through its three thermocouples. With a single zone controller, a firing will be stopped if the thermocouple (t/c) fails. The zone control with 3 t/c's, will continue to fire if one or two of its thermocouples fail during a firing. If the top or bottom thermocouple fails, that section will be controlled by the middle t/c. If the middle thermocouple fails the middle section will be controlled by the top t/c. If the controller is at "IdLE" and a t/c fails, the display will alternate between FAIL and the number of the failed t/c (1,2,3). The temperature of each zone can be viewed. The temperature will alternately flash with the currently selected zone. To select zone 1, press the "1" key and TC 1 will alternate with the current zone 1 temperature. For zone 2 press the "2" key, for zone 3 press the "3" key.

APPENDIX A - CONE FIRE TEMPERATURE PROFILES

Firing Profiles for cone 04, temperature 1945°F (1063°C)

<u>Slow Bisque</u>				<u>Slow Glaze</u>					
Segment	Rate	°F	Temperature	Stage	Segment	Rate	°F	Temperature	Stage Time
	/hr			Time		/hr			
3	80		250	2.25	5	150		250	1.20
4	200		1000	3.75	6	400		1695	3.61
5	100		1100	1.00	7	120		1945	2.08
6	180		1695	3.31					
7	80		1945	3.13					
13 hrs	26 mins		Total Time	13.43	6 hrs	54 mins		Total Time	6.90
<u>Fast Bisque</u>				<u>Fast Glaze</u>					
Segment	Rate	°F	Temperature	Stage	Segment	Rate	°F	Temperature	Stage Time
	/hr			Time		/hr			
3	120		250	1.50	6	570		1695	2.85
4	300		1000	2.50	7	200		1945	1.25
5	150		1100	0.67					
6	180		1695	3.31					
7	108		1945	2.31					
10 hrs	17 mins		Total Time	10.29	4 hrs	6 mins		Total Time	4.10

Firing Profiles for cone 6, temperature 2232°F (1222°C)

<u>Slow Bisque</u>				<u>Slow Glaze</u>					
Segment	Rate	°F	Temperature	Stage	Segment	Rate	°F	Temperature	Stage Time
	/hr			Time		/hr			
3	80		250	2.25	5	150		250	1.20
4	200		1000	3.75	6	400		1982	4.33
5	100		1100	1.00	7	120		2232	2.08
6	180		1982	4.90					
7	80		2232	3.13					
15 hrs	2 mins		Total Time	15.03	7 hrs	37 mins		Total Time	7.61
<u>Fast Bisque</u>				<u>Fast Glaze</u>					
Segment	Rate	°F	Temperature	Stage	Segment	Rate	°F	Temperature	Stage Time
	/hr			Time		/hr			
3	120		250	1.50	6	570		1982	3.35
4	300		1000	2.50	7	200		2232	1.25
5	150		1100	0.67					
6	225		1982	3.92					
7	108		2232	2.31					
10 hrs	54 mins		Total Time	10.90	4 hrs	36 mins		Total Time	4.60

These charts show the segments for the four cone fire speeds for cone 04 and cone 6. Notice that the firing profiles all end with segment 7 but they do not start at segment 1. The cone fire programs all end with segment 7 and count back to get to the beginning segment which is not segment 1. If you program a vary-fire program to mimic these profiles you would start numbering with segment 1, so for a Slow Glaze firing you would have only 3 segments, 1, 2, and 3. The firing rates for cone numbers other than cones 04 & 6 are the same as these but the end and final segment temperatures are different. The last segment (segment 7 in the cone fire profiles) always starts 250°F below the final cone temperature.

The actual temperature reached during a cone fire program will vary based on the rate of temperature rise during the last segment. This ensures the correct amount of heat-work is done with each cone fire

program. You can see the shut-off temperature by pressing “Review Program” after the firing has gone to CPLT. The temperature displayed after the cone number is the actual temperature that the kiln shut off.

APPENDIX B - ERROR CODES

NOTE: It is important to note the number of an error code if it occurs. The number or letter of the error will help determine what is happening with your kiln.

* Error codes with an asterisk are turned off when ERCd (Error Codes or Error Checking) is OFF. E- 1 is automatically turned back on during the last segment of a cone fire program even when ERCd is OFF.

Go to www.bartinst.com for more information on error codes and troubleshooting.

Error Code	Description	Comment
E- 0	Software Error. Check the selected program to ensure it is correct; reprogram if necessary.	If error persists or program does not hold in memory, return controller for service.
E- 1*	The temperature is increasing less than 12 degrees per hour during an up ramp in either cone fire or vary-fire mode. Pressing the "1" key clears the E- 1 and briefly displays the temperature and then the firing time at which the error occurred.	Error 1 is a problem with the kiln heating, not a controller problem. Do Full Power test (see description after this table) to check coils and relays. Low or dropping voltage to the kiln may be the cause. Incorrectly reading thermocouple or a thermocouple not placed correctly may be the cause also.
E- 2*	During a hold segment the temperature rises to greater than 50 degrees above the hold temperature. The temperature must stay 50° above this set temperature for 18 seconds before the error is displayed.	A relay latched in the “on” position may cause this. With glass firing if the kiln lid is opened for rapid cooling then closed it can possibly cause this.
E- 3*	During a hold segment the temperature is more than 50° below the hold temperature which was set. The temperature must stay 50° below this set temperature for 18 seconds before the error is displayed.	Relay failure may cause this.
E- 4*	The temperature is more than 50 degrees above the previous hold temperature during a ramp segment where the temperature is programmed to decrease. The temperature must stay 50° above this set temperature for 18 seconds before the error is displayed.	A relay latched in the “on” position may cause this. With glass firing if the kiln lid is opened for rapid cooling then closed it can possibly cause this.
E- 5*	The temperature is more than 50° below the travelling set-point temperature during a down ramp segment. The temperature must stay 50° below this set temperature for 18 seconds before the error is displayed.	Relay failure may cause this.
E- 6	A negative temperature is detected.	This generally indicates the thermocouple is connected incorrectly. Ensure the thermocouple extension wires are connected correctly to the controller and at all connection blocks back to the thermocouple.
E- 7	No longer a valid error code. E- d replaced this error code.	

E- 8	When using the Cone Fire Mode, the temperature is decreasing during the last ramp segment.	If the kiln has a kiln-sitter it may have turned the kiln off before the controller. Also, there may be a broken element or a relay may have failed.
ERRP	ERRP and the current temperature are alternately flashing. To clear the display, press the "1" key. The firing in progress will continue.	Power outage, kiln is still firing.
E- -	The E- with a dash indicates there was a power loss to the controller while writing a program to the non-volatile memory chip.	Turn the controller off and back on. Recheck the selected program, and reprogram if necessary.
E- E	The controller software has detected a hardware error. The controller must be returned for service.	Hardware error, return controller for service.
E- d*	The kiln temperature is more than 50°F above the travelling set-point. With a zone control kiln, any one of the zone temperatures is more than 50 degrees F above the travelling set point.	Can be caused by a stuck relay or stuck output. If zone control, then the outputs or t/c's may be in the wrong zones
E- A	Invalid program variable.	Reprogram all eight segments of program being fired; if problem persists return board for service.
E- r	RAM (random access memory) does not equal EEprom (memory chip).	Reprogram and try to fire again. If error persists return controller for repair.
E- U	Invalid 16 segment firing is attempted.	Re-program and restart firing.
E- H	Hardware error.	Controller must be returned for repair.
PF	Power Failure and the firing has been stopped.	See note below.
StUc	Key was held too long or is stuck	If problem persists after releasing key, have key pad replaced
FAIL	Steady FAIL message in the display indicates all thermocouples (t/c) have failed. If TC 1 alternately flashing with FAIL then t/c one in top section has failed. TC 2 flashing with FAIL, then t/c 2 (middle section) has failed. TC 3 flashing with FAIL, then t/c 3 (bottom section) has failed.	Check board temperature in Menu. If board temp (bd T) is approximately room temp then the t/c is defective. If display shows high temp. or FAIL without showing room temp then the circuit board is defective.

Full Power Test

The full power test is used to check the relays and elements of the kiln. Program a one segment Vary Fire program to go up as fast as possible to 1000°F and no hold (One segment, RA1 9999, °F 1 1000, HLd1 of 0) or program a Fast Glaze program to cone 04. Leave the lid of the kiln open and start the firing. Inspect the elements after the kiln has fired for 10 to 20 minutes. Observe each element from where it comes into the kiln all the way around to see that it is equally bright throughout.

The following observations are possible:

One section of the kiln is dark and not going on. This indicates a defective relay since there is usually one relay per section.

One element is not glowing at all. This indicates a broken element.

There are darker (cool) spots along the elements. This indicates worn elements.

The top and bottom elements appear brighter. This is normal for many kilns that have hotter elements in the top and bottom.

After you have made your observations turn off the kiln.

PF – Power Failure

Power was lost during a firing and the kiln temperature was below 140°F (60°C) or the kiln temperature dropped more than 250 degrees during the power outage.

APPENDIX C - Common Questions and Situations

Q. During programming of a firing, I typed a wrong number. How do I correct this?

- A.** Before pressing ENTER, enter zero until all zeros are displayed, then enter the correct number. If you have already pressed ENTER, you must press enter to progress through to the end of the program then start the program again.

Q. How do I clear the “PF” from the display?

- A.** Press the “1” key. After several seconds the current temperature will be displayed. Several other numbers or STOP may be displayed before the current temperature.

Q. What does it mean when “FAIL” is displayed?

- A.** Most likely the t/c (thermocouple) is defective. See P. 18 ("bd T", board temperature) to determine if the t/c or circuit board is at fault. If the t/c is faulty, it may actually be poor connections on any extension wire rather than the t/c itself. For type K thermocouples check all connections and ensure that yellow wires are connected to yellow wires and red to red all the way from the circuit board to the t/c in the kiln. It is a good idea to loosen the screw connections and then retighten them to break any oxide that may have built up. When connecting the thermocouple, connect the RED wire to the connector with RED dot and connect the YELLOW wire to the connector with the “+”. On type "K" thermocouples, the RED wire is always negative, and the YELLOW wire is positive. On type “S” thermocouples the RED wire is negative and the BLACK wire is positive.

Q. How can I find out the final temperature that was reached during a cone firing?

- A.** At the end of a cone fire, the firing time and CPLt will be flashing alternately in the display. Press “STOP”. Then press “Review Program”, the final temperature will display after oF. This final temperature will be retained until the next firing or until the controller is reprogrammed or turned off.

Q. What is a segment?

- A.** A segment is the basic building block of a program either in cone-fire or vary-fire (ramp/hold). Each segment consists of a ramp rate in degrees per hour, a temperature you want to achieve, and whether you want to hold there or not. For example, a program for drying ware going at 60°/hour to 200°F and holding for 2 hours would be a one segment firing, the ramp is 60, the temperature is 200, and the hold is 2.00.

Q. Do I need to use witness cones for each firing?

- A.** After checking your kiln with witness cones for the first few firings, if you are satisfied with the results you are getting and how even the kiln is from top to bottom then you do not need to use cones in each firing. It is a good practice to periodically place witness cones in the kiln to check for proper firing. If you suspect a problem or your results have changed then it is a good idea to check the operation of the kiln with witness cones.

APPENDIX D - Firing Program Blank

Keep this page as a Master and photocopy as needed

Firing Program Number: _____

Segment	Rate per Hour	Temperature	Hold
1			
2			
3			
4			
5			
6			
7			
8			

Firing Program Number: _____

Segment	Rate per Hour	Temperature	Hold
1			
2			
3			
4			
5			
6			
7			
8			

APPENDIX E - Connection Diagram

